

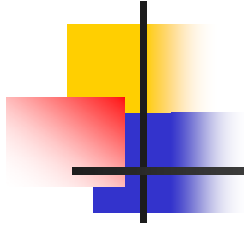

Hinweise und Anregungen für die Errichtung eines Funknetzes

Funk-Electronic Piciorgros GmbH
Claudiastr. 5
51149 Köln

Michael D. Piciorgros



Richtantenne sendet zu einem Rundstrahler - beide vertikal polarisiert

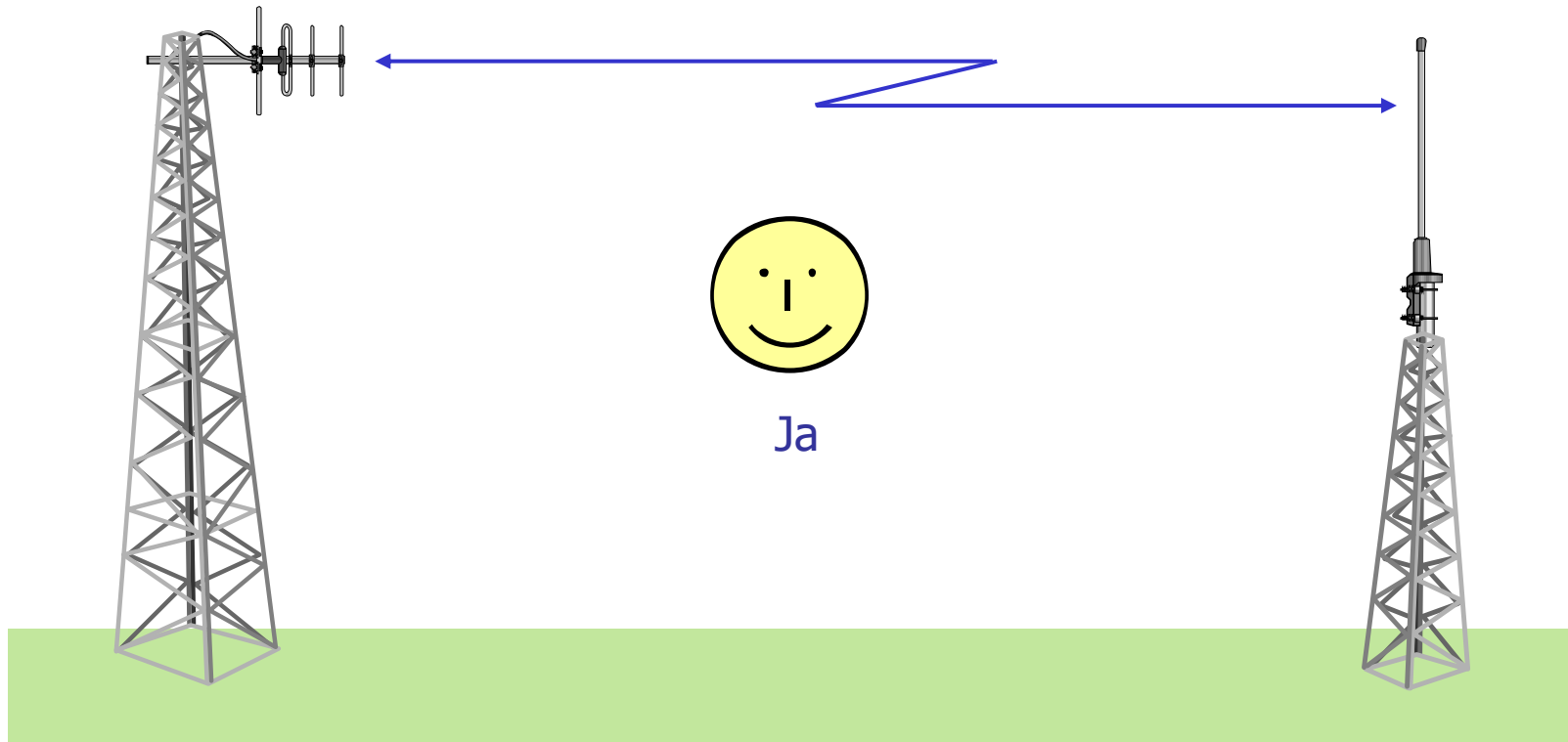

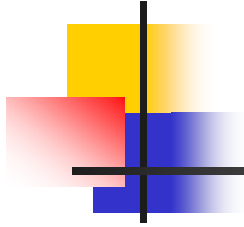

Falsche Antennenkonfiguration mit vertikal polarisiertem Rundstrahler
und horizontal ausgerichteter Richtantenne. Verlust dadurch:
zusätzlich 20dB

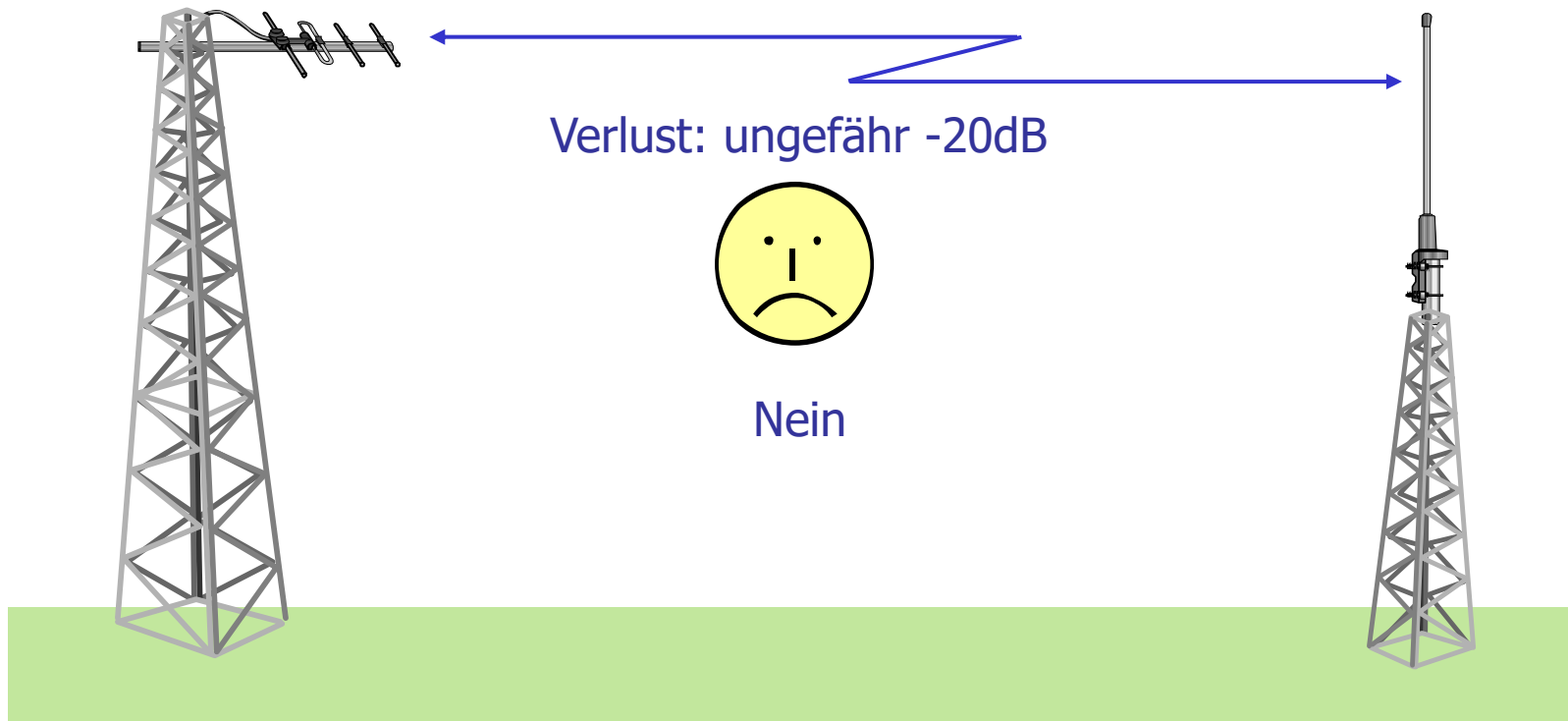

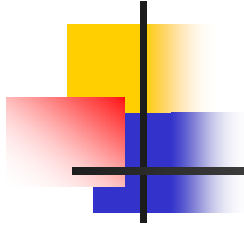

Punkt zu Punkt Funkverbindung mit Verwendung eines Funk-Repeater mit zwei Richtantennen

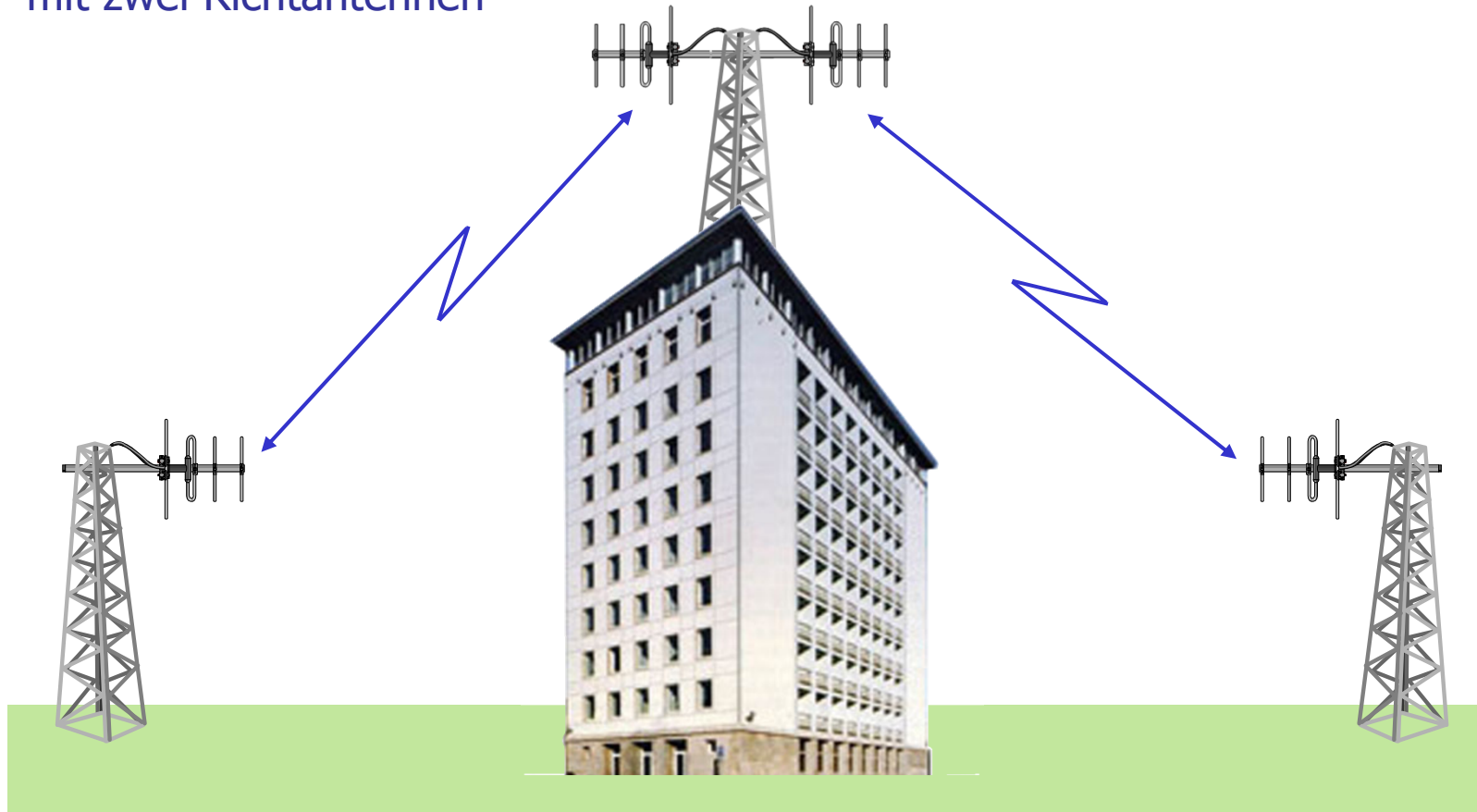

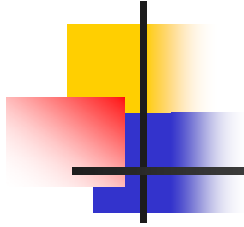

Punkt zu Punkt zu Multipunkt Funkverbindung

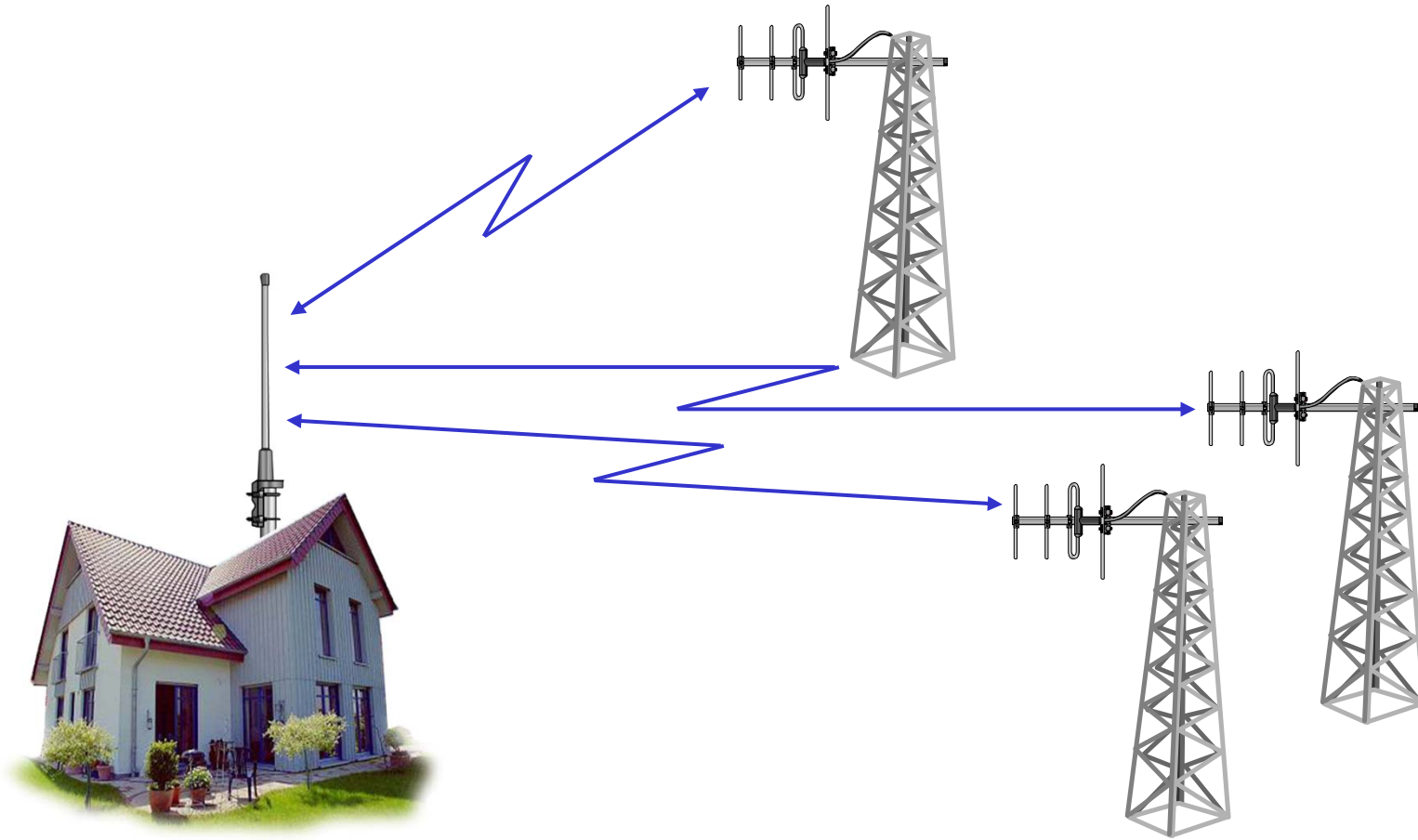

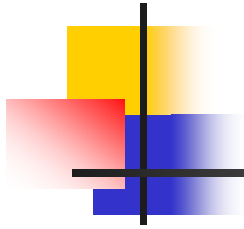

Punkt zu Multipunkt Funkverbindung mit einem Funk-Repeater

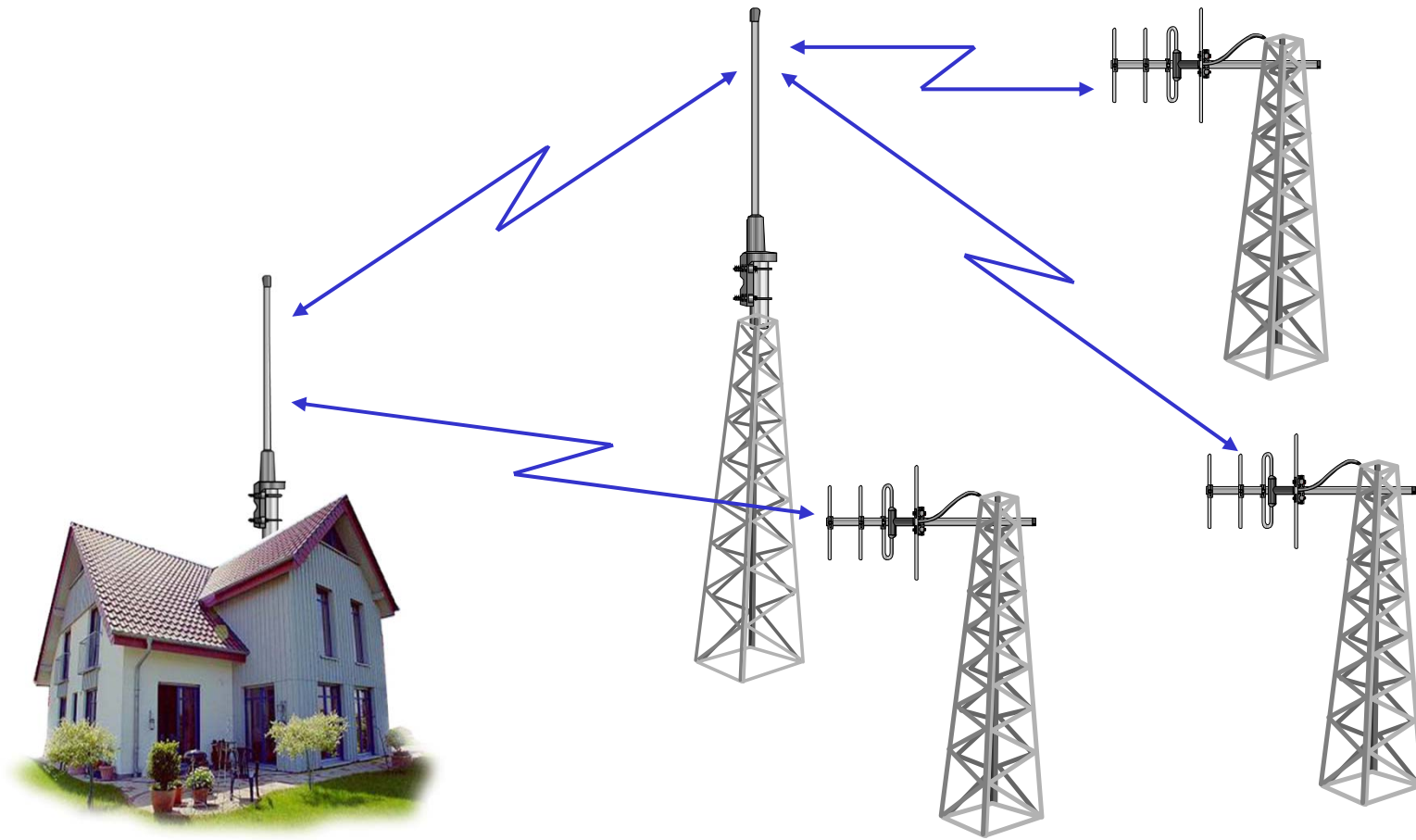

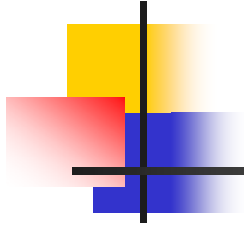

Antennenmontage

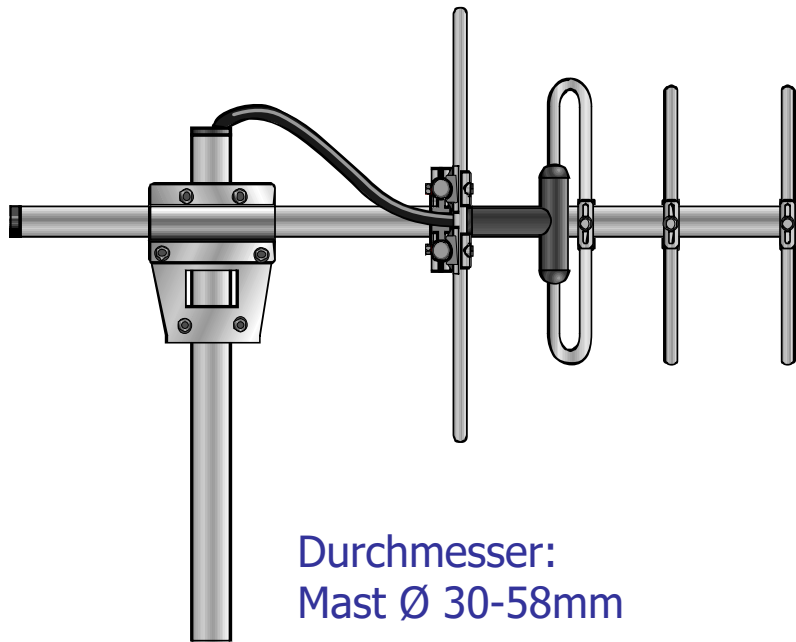

Durchmesser:
Mast \varnothing 30-58mm

Richtantenne
Procom R70-7/...

**Aufmast-
montage**

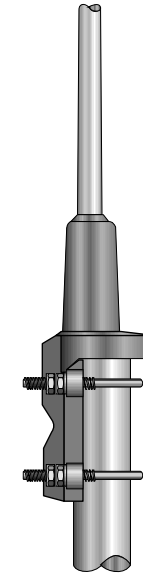

**Vormast-
montage**

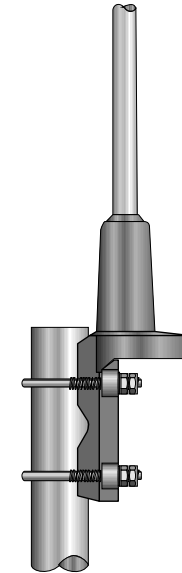

Durchmesser:
Mast \varnothing 16-54mm

Rundstrahler
Procom CXL 70-1LW/...

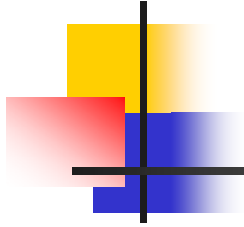

JBL-HD Aufrüstsatz Schwere Ausführung, zur Montage von Richtantennen an Masten bis ca. 117 mm Durchmesser

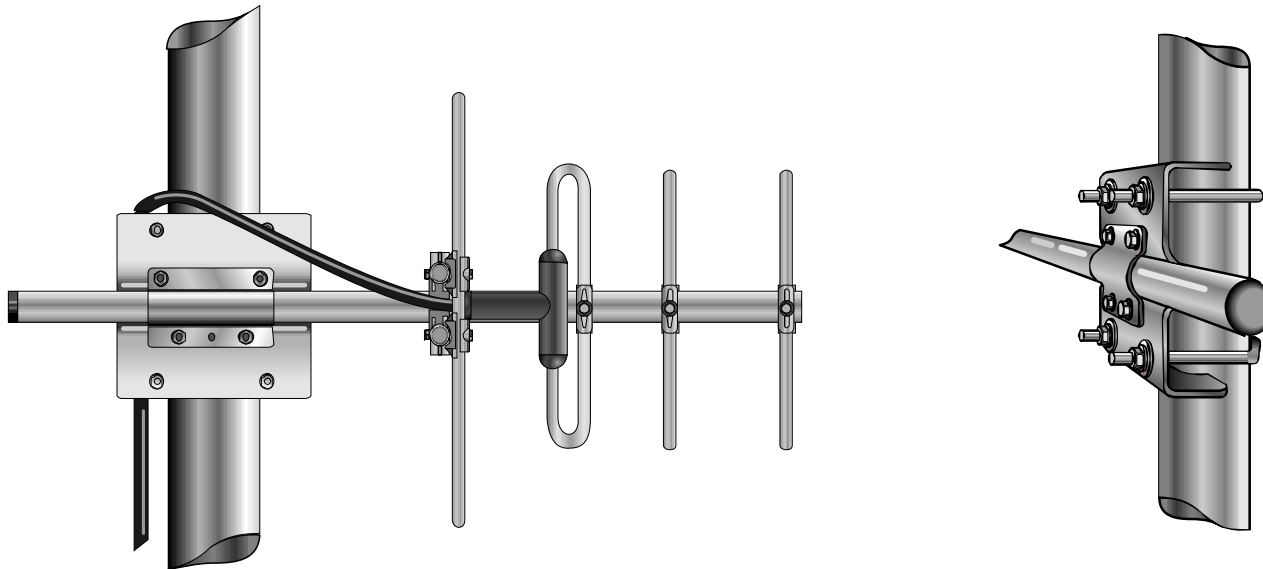

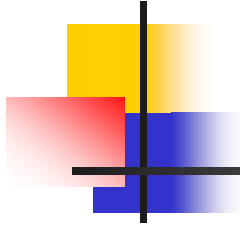

Antennendiagramm für Richtantennen Typ Procom R70

Typisches Strahlungsdiagramm (H-Plane)

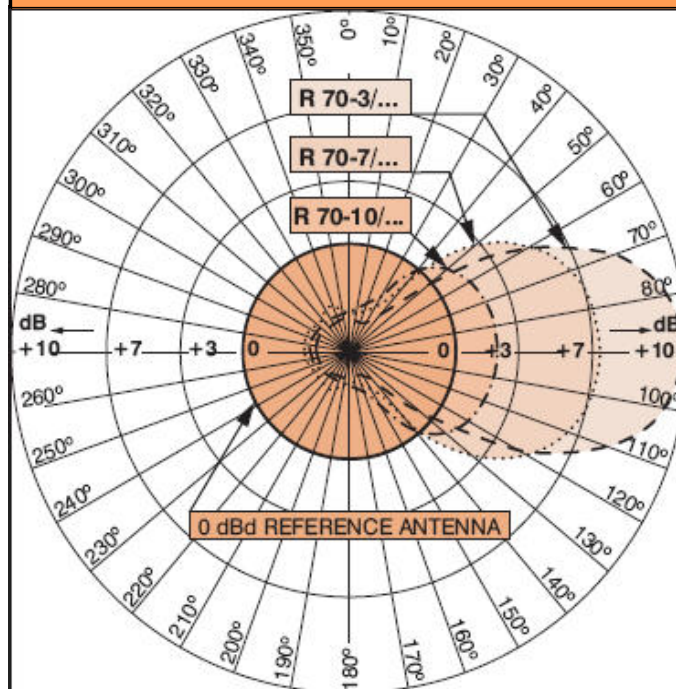

Typisches Strahlungsdiagramm (E-Plane)

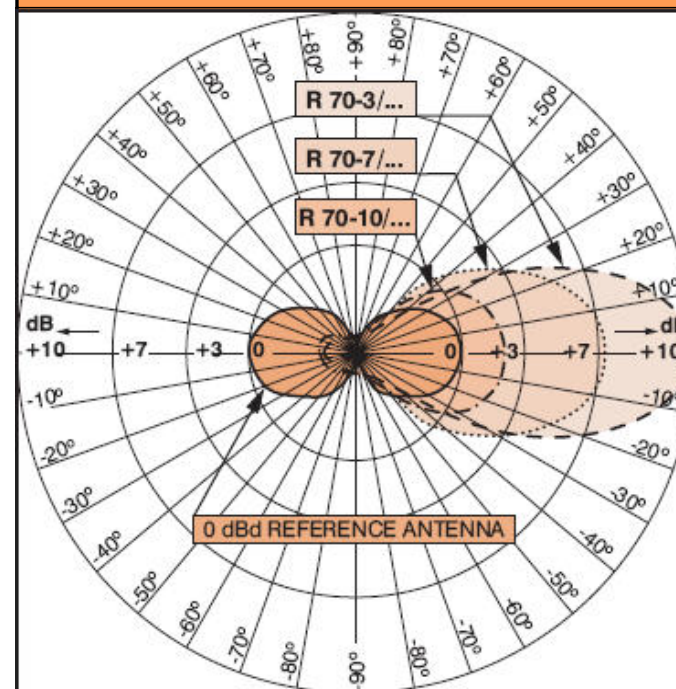

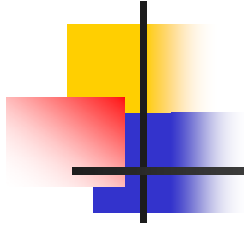

Antennendiagramm für Rundstrahler Typ CXL-70

Typisches Strahlungsdiagramm vertikal

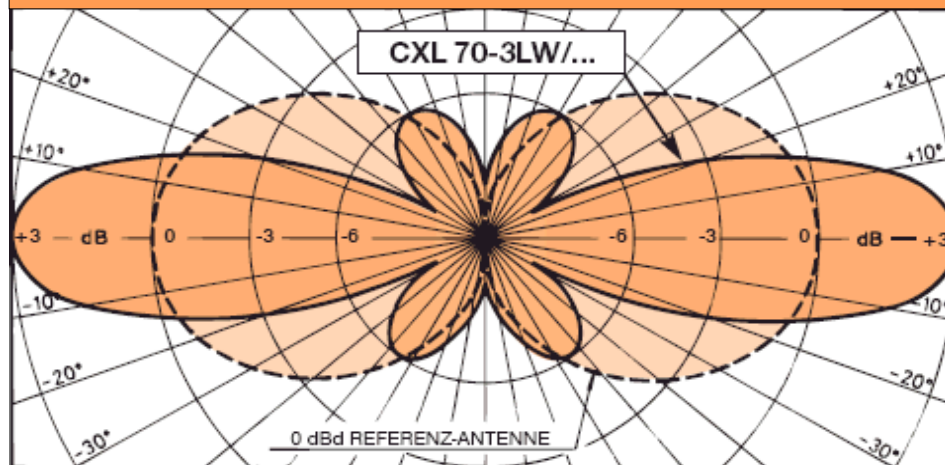

Typisches Strahlungsdiagramm horizontal

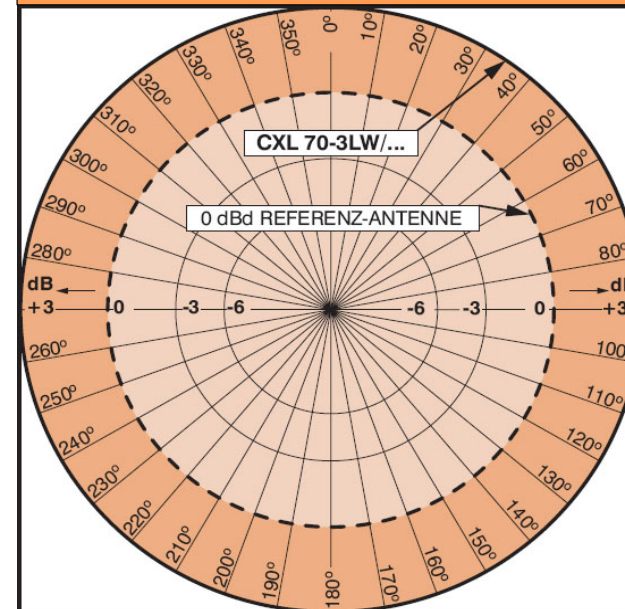

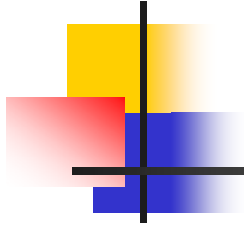

Konfektionierte Antennenkabel

BNC-RG58-N - Antennenkabel bis 5m



BNC-RG213-N - Antennenkabel bis 15m

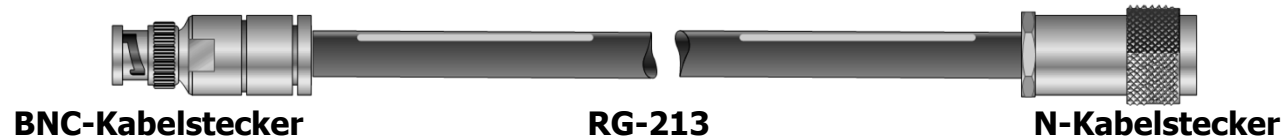

Antennenkabel ab 15m

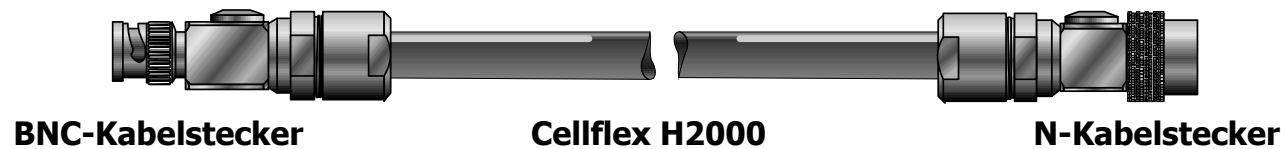

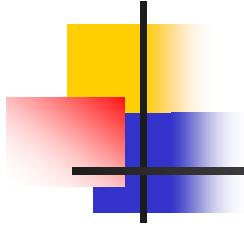

Zubehör

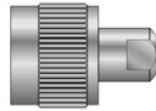

N-FME-Stecker für
FME-RG58-FME Kabel

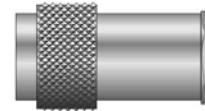

N-Stecker für RG213

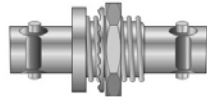

BNC-BNC Durchführung



BNC-FME-Stecker für
FME-RG58-FME Kabel



N-BNC-Adapter

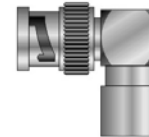

BNC(W)-FME Winkelstecker für
FME-RG58-FME Kabel

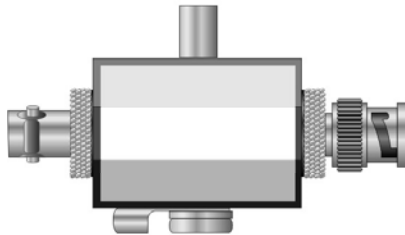

GES10 Blitzschutz
BNC(m) - BNC (f)

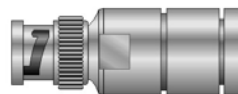

BNC-Stecker für RG213

Antennenkoppler
AK-2F1A

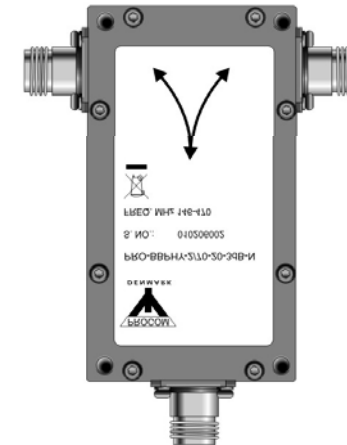

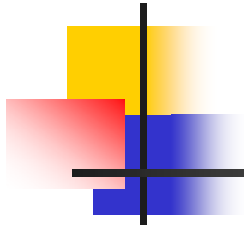

Montage und Demontage

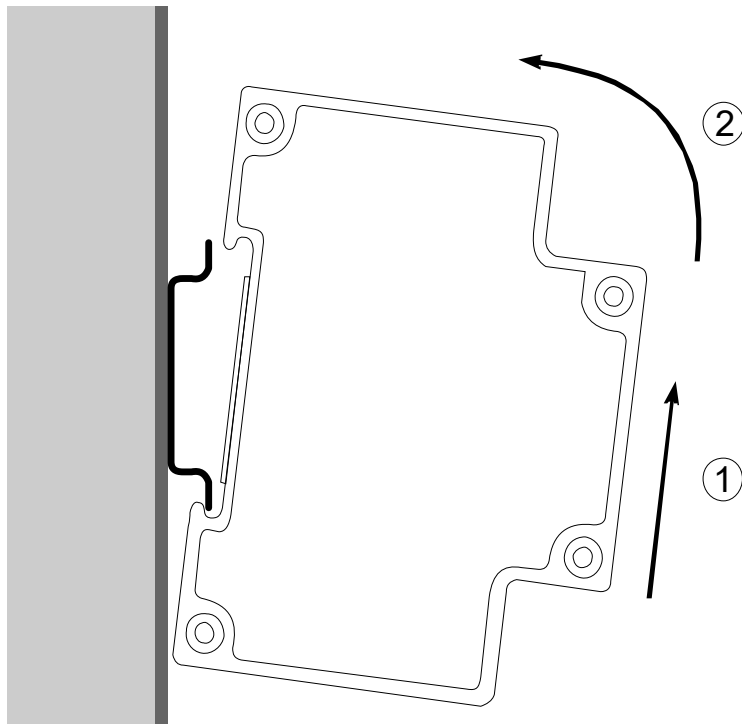

Montage

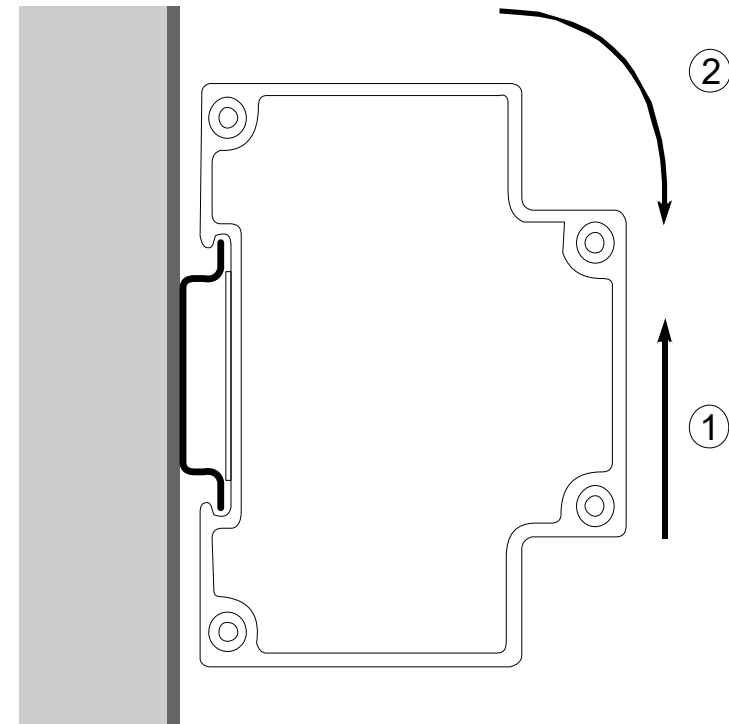

Demontage